







**CL.1 Deck-mounted basin spout without pop-up waste - Champagne (22kt Gold)**

CL.1

13 714 705



- 160mm projection
- fixed spout
- rectangular spray pattern with 40 individual jets
- height of mixer 108 mm
- height up to aerator 94 mm
- hole diameter 35 mm
- 2x screw-in M 10 x 1 pressure hose, leak-tested
- 1/2" connection
- max. flow 4 l/min
- lead-free
- This product can help a building meet the requirements of Green Building Rating Systems, e.g. LEED®, BREEAM®, DGNB

|   |                               |               |
|---|-------------------------------|---------------|
|  | Champagne (22kt Gold)         | 13 714 705-47 |
|  | Chrome                        | 13 714 705-00 |
|  | Brushed Platinum              | 13 714 705-06 |
|  | Dark Chrome                   | 13 714 705-19 |
|  | Brushed Champagne (22kt Gold) | 13 714 705-46 |
|  | Brushed Dark Platinum         | 13 714 705-99 |

13 714 705  
mm [inches]

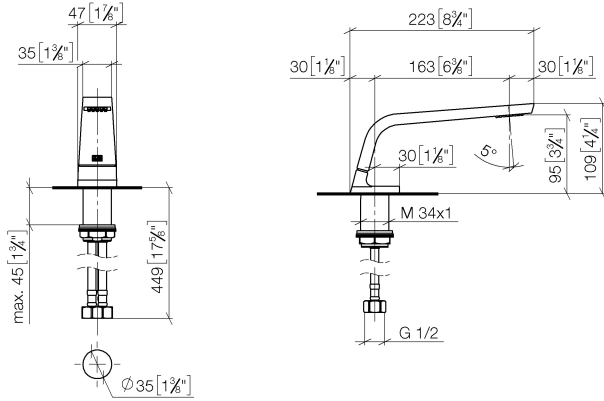

**Flow rate chart**

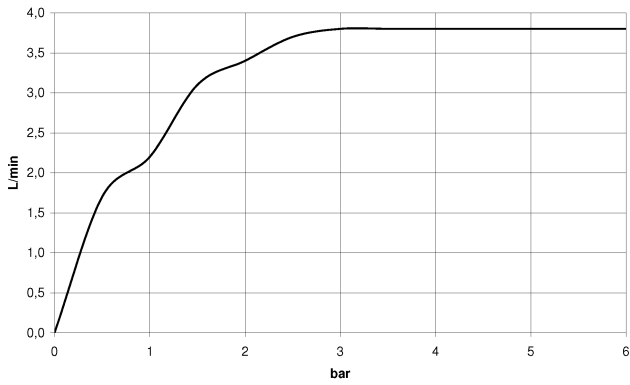

**Certificates**

GDV\_0400279. IAPMO\_N-4976. IAPMO\_8834 (1). IAPMO\_6397.

CL.1 Deck-mounted basin spout without pop-up waste - Champagne (22kt Gold)

CL.1

13 714 705  
Parts for other  
finishes can be found  
here: [Chrome](#)

